

ARPL-3W-EPS Day White (13W3)



FEATURES

- Long operating life
- Highest flux
- Available in White:2500K-25000K
- Lambertian radiation pattern
- More energy efficient than incandescent and most halogen lamps
- Low voltage DC operated
- Cool beam, safe to the touch
- Instant light (less than 100ns)
- Fully dimmable
- No UV
- Superior ESD protection
- RoHS compliant

RADIATION PATTERN

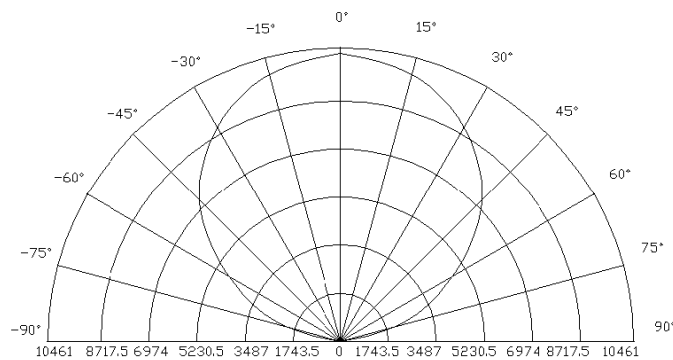

APPLICATIONS

- Fiber optic alternative/Decorative/entertainment
- Mini-accet/Up lighters/Down lighters/Orientation
- Indoor/Outdoor commercial and Residential Architectural
- Cove/Under shelf/Task
- Bollards/Security/Garden
- Portable(flashlight,bicycle)
- Edge-lit signs(Exit,point of sale)
- Automotive Exit (Stop-Tail-Turn,CHMSL,Mirror Side Repeat)
- Traffic signaling/Beacons/RailCrossing and Wayside

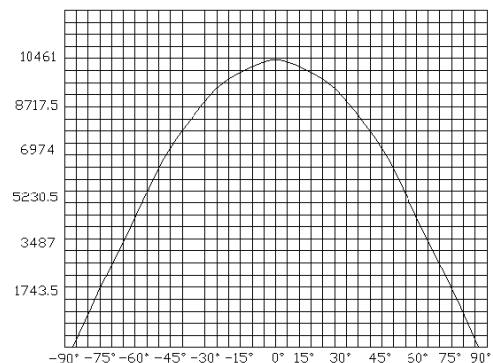

ELECTRICAL / OPTICAL CHARACTERISTICS AT TA=25°C

Item	Symbol	Condition	Min.	Typ.	Max.	Unit
Forward Voltage	$V_F (R)$	IF=350mA	3.0	--	3.8	V
Reverse Current	I_R	VR=5V	--	--	30	uA
50% Power Angle	$2\theta_{1/2}$	IF=350mA	120		140	deg
Luminous Intensity	$\phi_V(R)$	IF=350mA	180	200		lm
Recommend Forward Current	I_F	--	--	--	700	mA
Chromaticity	Tc	IF=350mA	4000		5000	K
Thermal Resistance,Junction to Case	RJP	IF=350mA	--	10	--	°C/w

Notes:

1. Tolerance of measurement of forward voltage $\pm 0.1V$.
2. Tolerance of measurement of peak Wavelength $\pm 2.0nm$.
3. Tolerance of measurement of luminous intensity $\pm 15\%$.

ABSOLUTE MAXIMUM RATING

Item	Symbol	Absolute Maximum Rating	Unit
Forward Current	I_F	700	mA
Peak Forward Current*	I_{FP}	1000	mA
Reverse Voltage	V_R	5	V
Power Dissipation	P_D	3000	mW
Electrostatic discharge	E_{SD}	±2000	V
Operation Temperature	T_{OPR}	-40~+80	°C
Storage Temperature	T_{STG}	-40~+100	°C
Lead Soldering Temperature*	T_{SOL}	Max. 260°C for 3sec Max.	

*IFP Conditions: Pulse Width ≤ 10msec duty ≤ 1/10

* All high power emitter LED products mounted on aluminum metal-core printed circuit board, can be lighted directly, but we do not recommend lighting the high power products for more than 5 seconds without a appropriate heat dissipation equipment.

* Re-flow, wave peak and soak-stannum soldering etc. is not suitable for this products.

* Suggest to solder it by professional high power LED soldering machine.

* Can use invariable-temperature searing-iron with soldering condition: ≤ 260 degree less than 3 seconds.

TYPICAL OPTICAL/ELECTRICAL CHARACTERISTICS CURVES

($T_a = 25^\circ\text{C}$ Unless Otherwise Noted)

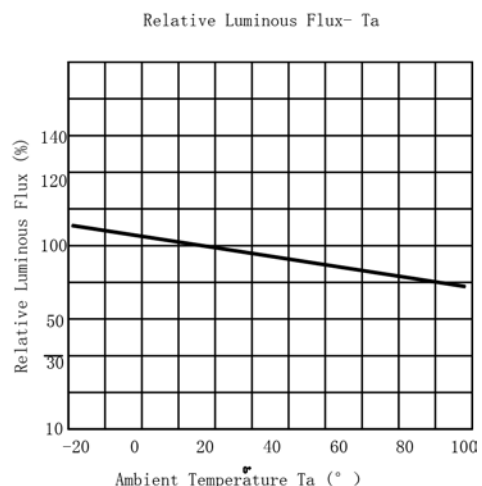
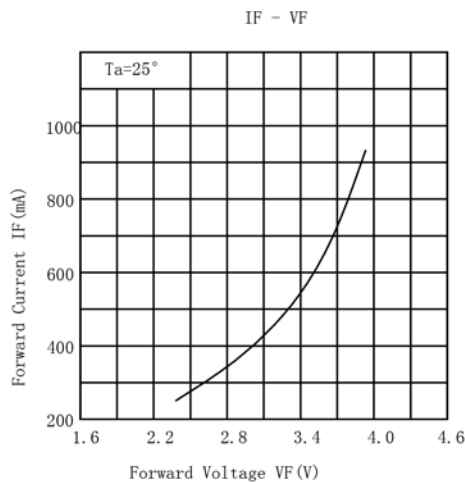
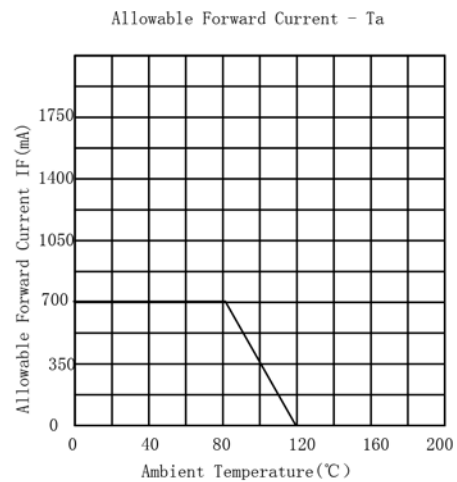
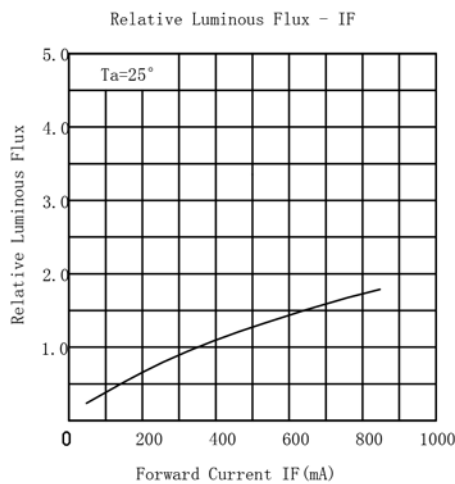

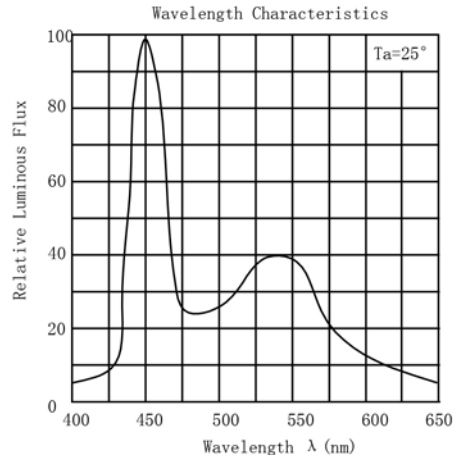

PACKAGE DIMENSIONS

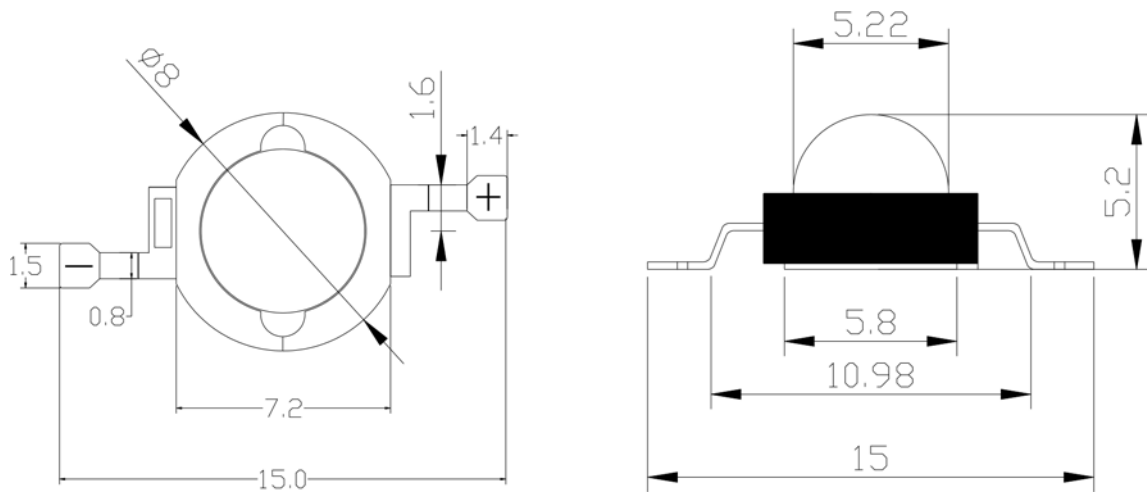

Notes:

1. All dimension units are millimeters.
2. All dimension tolerance is $\pm 0.2\text{mm}$ unless otherwise noted.

